

DAIKIN

OPERATION MANUAL

Remote controller

Switching from limit operation mode to automatic operation mode (heat pump models only) is not supported for Sky Air indoor models.

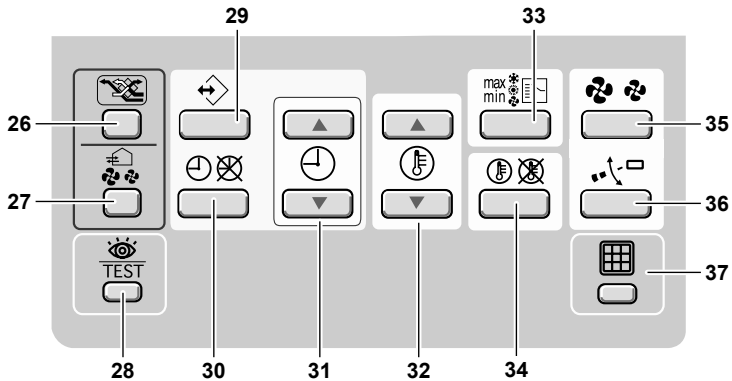
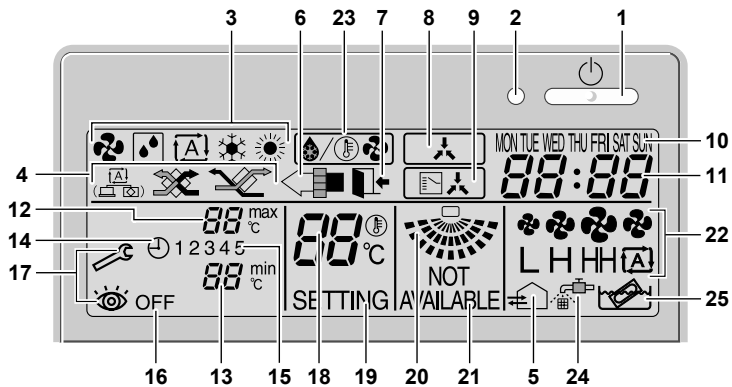

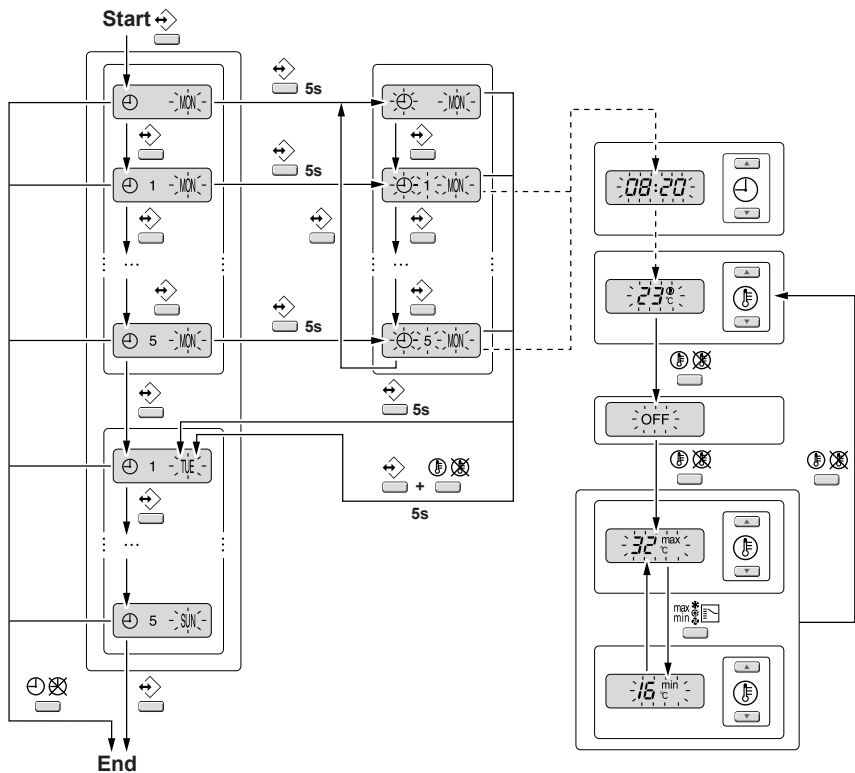



THANK YOU FOR PURCHASING THIS CONTROLLER. READ THE MANUAL ATTENTIVELY BEFORE USING THE INSTALLATION. AFTER READING THE MANUAL, STORE IT IN A SAFE PLACE FOR FUTURE USE.



Before initial operation, contact your dealer to obtain all details concerning your air conditioning installation.

WARNING

- Never let the remote controller get wet, this may cause an electric shock or fire.
- Never press the buttons of the remote controller with a hard, pointed object. The remote controller may be damaged.
- Never inspect or service the remote controller yourself, ask a qualified service person to do this.

Contents

page

1. Features and functions	1
2. Name and function of switches and icons	2
3. Setting up the controller	4
4. Description of the operation modes	5
5. Operation.....	5
6. Programming the schedule timer	10

1. Features and functions

The BRC1D517 is a state of the art remote controller that offers full control over your installation.

1 BASIC REMOTE CONTROLLER

The basic remote controller functions are:

- ON/OFF,
- operation mode change-over,
- temperature adjustment,
- air volume adjustment
- air flow direction adjustment.

2 CLOCK FUNCTION

The clock functions are:

- 24 hours real time clock,
- day of the week indicator.

3 SCHEDULE TIMER FUNCTION

The schedule timer functions are:

- a maximum of 5 actions can be programmed for each day of the week (totalling 35 actions),
- schedule timer can be enabled/disabled at any time,
- linked to a set temperature or a LIMIT operation or an OFF operation,
- "last command" overrules previous command until next scheduled command.

4 LIMIT OPERATION

Limit operation provides thermostat control within the range of the set minimum and maximum temperature. The minimum temperature setting will trigger heating, the maximum temperature setting will trigger cooling.

5 LEAVE HOME

The leave home function prevents the room temperature from dropping when the occupants are out for a longer period. If the room temperature drops below 10°C, heating is started automatically. As soon as 15°C is reached, the controller returns to its original status.

6 BUTTON PERMISSION LEVEL

Three hierarchical permission levels can be set to limit the user action.

2. Name and function of switches and icons (Refer to figure 1)

1 ON/OFF BUTTON

Press the ON/OFF button to start or stop the system.

2 OPERATION LAMP

The operation lamp lights up during operation or blinks if a malfunction occurs.

3 OPERATION MODE ICON

These icons indicate the current operation mode (FAN, DRY, AUTOMATIC, COOLING, HEATING).

4 VENTILATION MODE ICON



These icons indicate the current ventilation mode (HRV only) (AUTOMATIC, HEAT EXCHANGE, BYPASS).

5 VENTILATION ICON

The ventilation icon appears when the ventilation is adjusted with the ventilation amount button (HRV only). Simultaneously, the ventilation amount is indicated by the fan speed icon (see 22).

6 AIR CLEANING ICON

This icon indicates that the air cleaning unit (option) is operational.

7 LEAVE HOME ICON

The leave home icon shows the status of the leave home function.

ON	Leave home is enabled
FLASHING	Leave home is active
OFF	Leave home is disabled

8 EXTERNAL CONTROL ICON

This icon indicates that another controller with higher priority is controlling or disabling your installation.

9 CHANGE-OVER UNDER CENTRALISED CONTROL ICON

This icon indicates that the change-over of the installation is under centralised control assigned to another indoor unit or optional cool/heat selector connected to the outdoor unit (= master remote controller).

10 DAY OF THE WEEK INDICATOR

MON TUE WED THU FRI SAT SUN

The day of the week indicator shows the current week day (or the set day when reading or programming the schedule timer).

11 CLOCK DISPLAY

The clock display indicates the current time (or the action time when reading or programming the schedule timer).

12 MAXIMUM SET TEMPERATURE 

The maximum set temperature indicates the maximum set temperature when in limit operation.

13 MINIMUM SET TEMPERATURE 

The minimum set temperature indicates the minimum set temperature when in limit operation.

14 SCHEDULE TIMER ICON 

This icon indicates that the schedule timer is enabled.

15 ACTION ICONS 1 2 3 4 5

These icons indicate the actions for each day of the schedule timer.

16 OFF ICON OFF

This icon indicates that the OFF action is selected when programming the schedule timer.

17 INSPECTION REQUIRED  and 

These icons indicate that inspection is required. Consult your installer.

18 SET TEMPERATURE DISPLAY 

This indicates the current set temperature of the installation (not shown in LIMIT operation or in FAN or DRY mode).

19 SETTING SETTING

Not used, for service purposes only.

20 AIR FLOW DIRECTION ICON 

This icon indicates the air flow direction (only for installations with motorised air flow flaps).

21 NOT AVAILABLE 

NOT AVAILABLE is displayed whenever a non-installed option is addressed or a function is not available.

22 FAN SPEED ICON 

This icon indicates the set fan speed.

23 DEFROST/HOTSTART MODE ICON 

This icon indicates that the defrost/hotstart mode is active.

24 AIR FILTER CLEANING TIME ICON 

This icon indicates the air filter must be cleaned. Refer to the manual of the indoor unit.

25 ELEMENT CLEANING TIME ICON 

This icon indicates the element must be cleaned (HRV only).

26 VENTILATION MODE BUTTON 

The ventilation mode button operates the HRV; refer to the HRV manual for more details.

27 VENTILATION AMOUNT BUTTON 

This button sets the ventilation amount; refer to the HRV manual for more details.

28 INSPECTION/TEST OPERATION BUTTON 

Not used, for service purposes only.

29 PROGRAMMING BUTTON 

This button is a multi-purpose button. Depending on the previous manipulations of the user, the programming button can have various functions.

30 SCHEDULE TIMER BUTTON

This button enables or disables the schedule timer.

31 TIME ADJUST BUTTON

These buttons are used to adjust the clock or, when in programming mode, to adjust the programmed action time. Both buttons have an auto-repeat function.

32 TEMPERATURE ADJUST BUTTONS



These buttons are used to adjust the current setpoint or, when in programming mode, to adjust the programmed setpoint temperature (step = 1°C). Both buttons are also used to adjust the day of the week.

33 OPERATION CHANGE/MIN-MAX BUTTON



This button is a multi-purpose button. Depending on the previous manipulations of the user, it can have following functions:

- 1 select the operation mode of the installation (FAN, DRY, AUTOMATIC, COOLING, HEATING)
- 2 toggle between minimum temperature and maximum temperature when in limit operation

34 SETPOINT/LIMIT BUTTON

This button toggles between setpoint, limit operation or OFF (programming mode only).

35 FAN SPEED BUTTON

This button toggles between L (Low), H (High), HH (very High),  (Automatic).

36 AIR FLOW DIRECTION ADJUST BUTTON



This button enables to adjust the air flow direction.

37 AIR FILTER CLEANING TIME ICON RESET BUTTON

This button is used to reset the air filter cleaning time icon.





3. Setting up the controller





After initial installation, the user can set the clock and day of the week.

The controller is equipped with a schedule timer that enables the user to operate the installation automatically; setting the clock and day of the week is required to be able to use the schedule timer.

1 CLOCK SETTING FUNCTION

Hold down the  button for 5 seconds. The clock read-out and the day of week indicator will blink, both can now be adjusted.

Use the  &  buttons to adjust the clock. Each time pressing the time adjust button will in/decrease the time by 1 minute. Keeping the  or  button pressed will in/decrease the time by 10 minutes.

Use the  &  buttons to adjust the day of the week. Each time pressing the  or  buttons will display the next or previous day.

Press the  button to confirm the current set time and day of the week.

If the controller, with blinking clock and day of week read-out, is left untouched for 5 minutes, the clock and day of the week will return to their previous settings; the clock setting function is no longer active.

2 SETTING UP THE SCHEDULE TIMER

To set up the schedule timer, refer to chapter 6. "Programming the schedule timer" on page 10.

4. Description of the operation modes

1 FAN ONLY OPERATION

In this mode, air only circulates without heating or cooling.

2 DRY OPERATION

In this mode, the air humidity will be lowered with a minimal temperature decrease.

The temperature and fan speed are controlled automatically and cannot be controlled by the remote controller.

Dry operation will not function if the room temperature is too low.

3 AUTOMATIC OPERATION

In this mode, the controller will automatically switch between heating and cooling as required by the setpoint or limit temperature.

4 COOLING OPERATION

In this mode, cooling will be activated as required by the setpoint or limit temperature.

5 HEATING OPERATION

In this mode, heating will be activated as required by the setpoint or limit temperature.

Hot start (heat pump types only)

At the start of a heating operation, the indoor fan is stopped until a certain indoor heat exchanger temperature is reached and  is displayed. This prevents cold air from leaving the indoor unit.

Defrost (heat pump types only)

In heating operation, freezing of the outdoor heat exchanger may occur. If so, the heating capacity of the system lowers and the system goes into defrost operation. The indoor unit fan stops and  is displayed. After maximum 10 minutes of defrost operation, the system returns to heating operation again.

6 LIMIT OPERATION min^{C} & max^{C}

Limit operation is an additional mode that enables to keep the room temperature within certain limits. The min^{C} & max^{C} icons are displayed to confirm the activation of the limit operation.

7 LEAVE HOME

LEAVE HOME is a feature that enables to keep the room temperature above 10°C when the occupants are out. This function will switch on heating if the installation is switched off.





5. Operation

Manual operation



In manual operation, the user decides about the settings of the installation. The last setting remains active until the user changes it.

As the controller can be implemented for a wide variety of installations and features, it might occur that you select a function that is not available on your installation; if this is the case, the NOT AVAILABLE message will appear.

Use the  button to select the desired operation mode.





	Fan only operation
	Dry operation
	Automatic operation
	Cooling operation
	Heating operation

Press the  button to toggle between limit operation and the operations listed above.

In limit operation, use the  button to select minimum and maximum temperature settings. Use the  or  buttons to adjust the minimum and maximum temperature settings.



1 FAN ONLY OPERATION

User adjustable parameters:

- Fan speed, use the  button,
- Air flow direction adjust, use the  button,
- Ventilation mode, use the  button,
- Ventilation amount, use the  button.







2 DRY OPERATION

User adjustable parameters:

- Air flow direction adjust, use the  button,
- Ventilation mode, use the  button,
- Ventilation amount, use the  button.







3 AUTOMATIC OPERATION

User adjustable parameters:

- Setpoint temperature, use the  &  buttons,
- Fan speed, use the  button,
- Air flow direction adjust, use the  button,
- Ventilation mode, use the  button,
- Ventilation amount, use the  button.







4 COOLING OPERATION

User adjustable parameters:

- Setpoint temperature, use the  &  buttons,
- Fan speed, use the  button,
- Air flow direction adjust, use the  button,
- Ventilation mode, use the  button,
- Ventilation amount, use the  button.





5 HEATING OPERATION

User adjustable parameters:

- Setpoint temperature, use the  &  buttons,
- Fan speed, use the  button,
- Air flow direction adjust, use the  button,
- Ventilation mode, use the  button,
- Ventilation amount, use the  button.





6 LIMIT OPERATION

User adjustable parameters:

- Fan speed, use the  button,
- Air flow direction adjust, use the  button,
- Ventilation mode, use the  button,
- Ventilation amount, use the  button.

ADDITIONAL FEATURES OF THE CONTROLLER





1 LEAVE HOME

Press the   and   buttons simultaneously to enable the LEAVE HOME function.



KEEP IN MIND THAT THE  BUTTON MUST BE OFF TO GUARANTEE TRIGGERING OF THE LEAVE HOME FUNCTION.

2 Adjusting the air flow direction

Use the  button to adjust the air flow direction. Press the button to switch between fixed or variable air flow direction. Use the  icon to determine the fixed air flow direction by pressing the  button when the  icon indicates the desired direction.

NOTE

Even if fixed air flow direction is selected, variable air flow direction can be enabled automatically to preserve proper operation of your installation.



3 SCHEDULE TIMER

All features and operation and programming of the schedule timer are described below.

Schedule timer operation





In schedule timer operation, the installation is also controlled by the schedule timer. The actions programmed in the schedule timer will be executed automatically.

The schedule timer always executes the last command; this means the user can temporarily overrule the last executed programmed action. Refer to "Manual operation" on page 5. The next programmed action (in the schedule timer) will return control to the schedule timer.

Use the  button to enable or disable the schedule timer.

NOTE



The schedule timer overrules the  button, only use the  button to enable or disable the schedule timer. The schedule timer is enabled when the  icon is visible. The  button only overrules the schedule timer until the next programmed action.



The programmed schedule is time driven. Make sure that the clock and day of the week are set correctly. Refer to "CLOCK SETTING FUNCTION" on page 4.



Manually adjust the clock for summertime and wintertime. Refer to "CLOCK SETTING FUNCTION" on page 4.



A power failure exceeding 1 hour will reset the clock and the day of the week. Refer to "CLOCK SETTING FUNCTION" on page 4 to adjust the clock and the day of the week.

The actions programmed in the schedule timer will not be lost after a power failure; reprogramming the schedule timer is not required.

To set up the SCHEDULE TIMER refer to chapter 6. "Programming the schedule timer" on page 10.

What can the schedule timer do?

The concept of the schedule timer is simple, straightforward though powerful.

The schedule timer can order 3 actions:

- 1 switch on the installation at a scheduled time, in combination with a setpoint (exact temperature control)
- 2 switch off the installation (end of control)
- 3 switch on the installation at a scheduled time, in limit operation

The schedule timer can accept a maximum of 5 actions per day.

For each day of the week a maximum of 5 actions can be programmed, totalling a maximum of 35 programmed actions. The action that was programmed first for a certain day is action 1, the last programmed action for a day could be action 1 (in case only one action is programmed for that day) to 5.



It is of utmost importance to understand that the number assigned to the programmed action, DOES NOT DETERMINE WHEN the programmed action will be executed. Only the TIME, being a part of the data entered when programming the action, will determine when the programmed action will be executed.

What will the schedule timer do?

If enabled, the schedule timer will execute the programmed actions.

It will order the installation to:

- cool or heat, depending on the current operation, if applicable; the setpoint will be displayed,

OR

- switch off the installation (the schedule timer remains enabled and reactivates the installation as programmed); the operation lamp will turn off,

OR

- cool or heat, whichever is required to keep the room temperature within a specified range (limit operation); t_c^{min} and t_c^{max} are displayed.



The schedule timer will change the operation mode in LIMIT operation only.

To be able to verify the programmed actions, you can browse the programmed actions, see below.

What will the schedule timer NOT do?

The schedule timer will not:

- control fan speed,
- control air flow direction,
- control ventilation mode,
- control ventilation amount,
- change the operation mode for a scheduled setpoint.

The parameters listed above can be set manually, without interfering with the schedule timer.

More sophisticated remote controllers are available. Consult your dealer for more information.



Browsing the programmed actions in the schedule timer (read-out only)

Refer to [figure 2](#).

Browsing the programmed actions of the schedule timer is a sequential process. Only 2 buttons are used to browse the entire schedule timer program.

The  button is used to start browsing, to display the next programmed action or to exit browsing when displaying the last programmed action.

The  button is used to exit browsing at once (without having to scroll through all programmed actions).

Press the  button to enter the browse mode, the  icon appears, MON will blink.

NOTE Browsing always starts on Monday and ends on Sunday.





Check the 1 2 3 4 5 icon. If at least 1 action is programmed for Monday, 1 will appear.

The clock indicates the time when the programmed action is scheduled, either 24°C , OFF or $15^{\circ}\text{C}^{\text{min}}$ and $30^{\circ}\text{C}^{\text{max}}$ is being displayed.

NOTE The temperatures mentioned above are for clarifying purposes only, temperature values on your controller may vary.





If 1 does not appear, it indicates that there are no programmed actions for Monday.

Press the  button again to go to the next day of the week.  will blink, this indicates that the programmed actions for Tuesday are being browsed.

The process described above is now restarted.

If at least 1 action is programmed for Tuesday, 1 will appear. The clock indicates the time when the programmed action will be enabled, either 24°C , OFF or $15^{\circ}\text{C}^{\text{min}}$ and $30^{\circ}\text{C}^{\text{max}}$ is being displayed.

If 1 does not appear, it indicates that there are no programmed actions for Tuesday.

Press the  button to display the next programmed action. If a second action is programmed for Tuesday,  will still be blinking and 1 2 will appear.

Assuming that 5 actions were programmed for Tuesday, a total of 5 presses will be required to display all programmed actions.

Continue pressing the  button until the day of the week indicator displays the current day (not blinking), you have now quit browsing.

NOTE



The number of times that the  button will have to be pressed to quit browsing depends on the number of programmed actions in the schedule timer.

How do I interpret the programmed actions

To be able to understand the behaviour of your installation when the schedule timer is enabled, it is important to look at all programmed actions for the current day and maybe the last programmed action of yesterday.

If the first programmed action for today is not active yet, the current status of your installation depends, most probably but not necessarily, on the last programmed action from yesterday. Read the important note below.

If the first programmed action for today is already active, the current status of your installation depends, most probably but not necessarily, on the parameters programmed in the first programmed action for today. Read the important note below.

NOTE



To keep the operation of your installation simple, the schedule timer settings can easily be overruled by altering the current setting ("last command" overrules previous command until next scheduled command).

Conclusion: Although  is displayed, somebody might have altered the settings. The next programmed action will overrule the altered settings and all settings return as programmed.

Programmed actions might overlap; due to the "last command overrules" logic, the last scheduled command will rule.

How do I interpret the readings on the display when the schedule timer is active

As described above, the schedule timer settings, (and as a consequence the display readings) might be overruled temporarily by a manual intervention.

If you want to be absolutely sure about the schedule timer settings for this very moment, you must browse the schedule timer programmed actions. Refer to "Browsing the programmed actions in the schedule timer" on page 8.

6. Programming the schedule timer

What do I have to program?

As the schedule timer is based on a week program (the same actions will be repeated every week) you will have to select the day of the week first.

Now you must choose an action:

- 1 switch on the installation at a scheduled time, in combination with a setpoint (exact temperature control)
- 2 switch off the installation (end of control)
- 3 switch on the installation at a scheduled time, in limit operation

Finally you must enter the time of the day when the action must be enabled.

NOTE



If you program 2 or more actions on the same day and at the same time of the day, only the action with the highest action number (2 - 5) will be executed.

Getting started

Programming the schedule timer is flexible (you can add, remove or alter programmed actions whenever required) and straightforward (programming steps are limited to a minimum).

Below are some tips and tricks to ensure successful programming of the schedule timer:

- familiarise yourself with the icons and the buttons, you will need them when programming,
- familiarise yourself with the browse function, you will need it to start programming. Refer to "Browsing the programmed actions in the schedule timer" on page 8,
- fill out the form at the end of this manual; note the time and the required action for each day (keep in mind that the number of actions is limited to 5 per day),
- take your time to enter all data accurately,
- try to program the actions for each day in logical sequence (start with action 1 for the first action and end with the highest number for the last action). This is not a requirement but it will make it much easier to interpret the program later,
- keep in mind that you can always alter, add or remove the programmed actions later.

Programming

1 THE SCHEDULE TIMER IS PROGRAMMED FOR THE FIRST TIME

NOTE When changing day during programming you will have to confirm "the last action". Each day can have 5 programmed actions (numbered 1 to 5) but for some reason you might want to delete one, several or all programmed actions.



To be able to delete programmed actions, you must select the last action that you want to keep, this can be 1 to 5 or no action (⊖) is displayed and no action displayed).

All programmed actions with a number HIGHER than the selected one, or all programmed actions if no last action was selected will be deleted.

PROGRAMMING THE FIRST DAY OF THE WEEK

NOTE In the guidelines below it is assumed that you start programming the schedule timer actions on Monday and end with the schedule timer actions for Sunday.



If you prefer NOT to start on Monday, first browse to the desired day and then enter the PROGRAM mode.

In this particular case, no actions have been programmed before, all schedule timer actions are idle.

- Browse to Monday by pressing the button. The ⊖ icon appears, MON will blink and one of the icons might be displayed but all other fields remain blank, indicating that no actions are programmed for Monday.
- Enter the program mode by holding down the button for 5 seconds, the ⊖ icon will now blink too.
- Press the button to activate the first programmed action.
- A blinking 1 is displayed indicating that the first programmed action for Monday is being programmed; The set temperature and clock display are blinking.
- Press the button to select either set temperature, OFF, or limit operation.
- Enter the desired temperature using the & buttons.
- Press the button to toggle between minimum set temperature and maximum set temperature in limit operation, the selected temperature will blink.
- Enter the time when the action must start using the & buttons (min. step = 10 minutes).

NOTE If, by accident, you pressed the button, you activated the next action; 1 2 is displayed (1 steady and 2 blinking). Press the button repeatedly until a blinking 1 is displayed. You can now continue adjusting the settings for the first schedule timer action.



If the action and the corresponding time are correct, you can proceed to the second schedule timer action. This is done by pressing the  button, the data is saved and the next schedule timer action can be programmed.

Programming the remaining schedule timer actions for the same day is similar.

You can browse the schedule timer actions by pressing the  button.



NOTE Don't worry if you add additional schedule timer actions by pressing the  button repeatedly, they can be deleted when finishing the current day.

When all data for the schedule timer actions for Monday are entered, you must confirm the programmed actions.

Make sure the last schedule timer action you want to keep is selected (schedule timer actions with a higher number will be deleted).

Now you must choose between 2 options:

1 CONFIRM AND COPY TO NEXT DAY





The schedule timer action programmed for the current day are also valid for the next day: use the "confirm last action and copy actions to next day" function by pressing the  and  buttons simultaneously for 5 seconds.

2 CONFIRM ONLY

The schedule timer action programmed for the current day are only valid for the selected day: use the "confirm last action and go to next day" function by pressing the  button for 5 seconds.



Program mode is quit and depending on the choice made, the programmed actions are saved for Monday (and possibly Tuesday).

PROGRAMMING THE OTHER DAYS OF THE WEEK



Programming the other days of the week is identical to programming the first day of the week.  is blinking to indicate the selected day,  and  are steady if actions were copied from Monday to Tuesday, only  is displayed if no actions were copied from Monday to Tuesday.





2 I WANT TO EDIT PROGRAMMED ACTIONS

Editing programmed actions is easy.

Make sure you are not in program mode ( not blinking); if required, press the   button to quit program mode.

Browse to the programmed actions using the  button, select the day and action you want to edit.

Press the  button for 5 seconds; program mode is enabled, the  icon and selected action are blinking. Edit the settings using the same buttons described above.

Select the "last action" using the  button and decide if you do or do not want to copy the programmed action(s) to the next day (pressing the  and  buttons simultaneously or only the  button for 5 seconds).

3 I WANT TO DELETE ONE OR MORE PROGRAMMED ACTIONS

Make sure you are not in program mode (⊖ not blinking); if required, press ⊖⊗ to quit program mode.

Browse to the programmed actions using the ⇄ button, select the day you want to edit.

Press the ⇄ button for 5 seconds; program mode is enabled, the ⊖ icon and selected action are blinking.

Select the "last action" you want to keep using the ⇄ button. All higher actions will be deleted.

Confirm the deletion by pressing the ⇄ button for 5 seconds,

OR

confirm the deletion for the current and the next day too by pressing the ⇄ and ⊖⊗ buttons simultaneously for 5 seconds.

NOTE In the case above, if for example the last action was 3, the programmed actions 4 and 5 will also be deleted (if they were present).



4 I WANT TO DELETE ALL PROGRAMMED ACTIONS AT ONCE

Quit programming or browsing.

Press the ⇄ and ⊖⊗ buttons simultaneously for 5 seconds; the ⊖ icon will invert and disappear to confirm deletion.

7. Maintenance

The remote controller does not need maintenance.

Remove dirt with a soft damp cloth.

NOTE Only use clear tapid water to moisten the cloth.



8. Troubleshooting

The guidelines below might help to solve your problem. If you cannot remedy the problem, consult your installer.

No readings on the remote controller (display blank)

Check if the mains power is still applied to your installation.

Only is displayed

This indicates that the installation has just been powered, please wait until  disappears.

The schedule timer does work but the programmed actions are executed at the wrong time (e.g. 1 hour too late or too early)

Check if the clock and the day of the week are set correctly, correct if necessary (refer to "CLOCK SETTING FUNCTION" on page 4).

I cannot enable the schedule timer (the ⊖ icon blinks for 2 seconds and disappears)

The schedule timer has not been programmed yet. First program the schedule timer (refer to "Programming the schedule timer" on page 10).

I cannot enable the schedule timer (the ^{NOT AVAILABLE} ⊖ icon is displayed)

The schedule timer can not be enabled when a centralised control is connected.

Limit operation cannot be selected

Limit operation is not available for cooling only installations.

NOTES

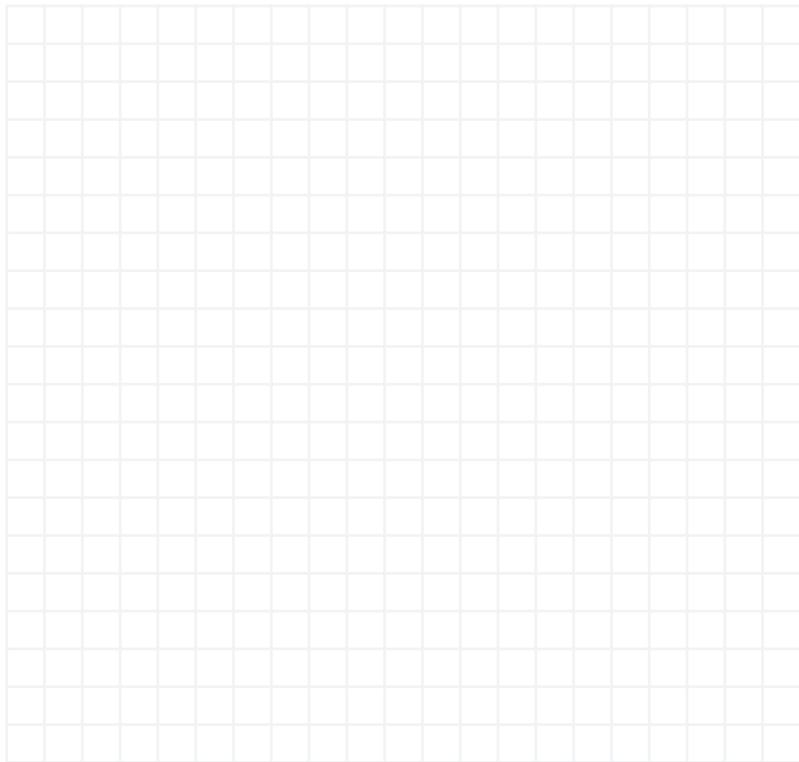

MON	1	2	3	4	5
⊖					
°C					
OFF					
max					
min					
TUE	1	2	3	4	5
⊖					
°C					
OFF					
max					
min					
WED	1	2	3	4	5
⊖					
°C					
OFF					
max					
min					
THU	1	2	3	4	5
⊖					
°C					
OFF					
max					
min					

DAIKIN

FRI	1	2	3	4	5
⊕					
°C					
OFF					
max					
min					
SAT	1	2	3	4	5
⊕					
°C					
OFF					
max					
min					
SUN	1	2	3	4	5
⊕					
°C					
OFF					
max					
min					

DAIKIN EUROPE NV

Zandvoordestraat 300, B-8400 Oostende, Belgium

4PWEN15196-1A